

Medeco-ch



service  
gesundheit  
mobilität  
hand  
freiheit  
hüfte  
knochen  
technologie  
**patient**  
wohlbefinden  
fuss  
knie  
ellbogen  
osteosynthese  
innovation

Ihr medizinischer Partner

gesundheits  
 mobilität hand  
 patient  
 wohlbefinden  
 fuss  
 knie  
 ellbogen  
 service  
 knochen  
 technologie  
 osteosynthese  
 innovation

KeriMedical



**TOUCH®**  
Daumensattelgelenk-Prothese  
mit doppelter Mobilität

**Motec®**  
Modulare Handgelenkprothese

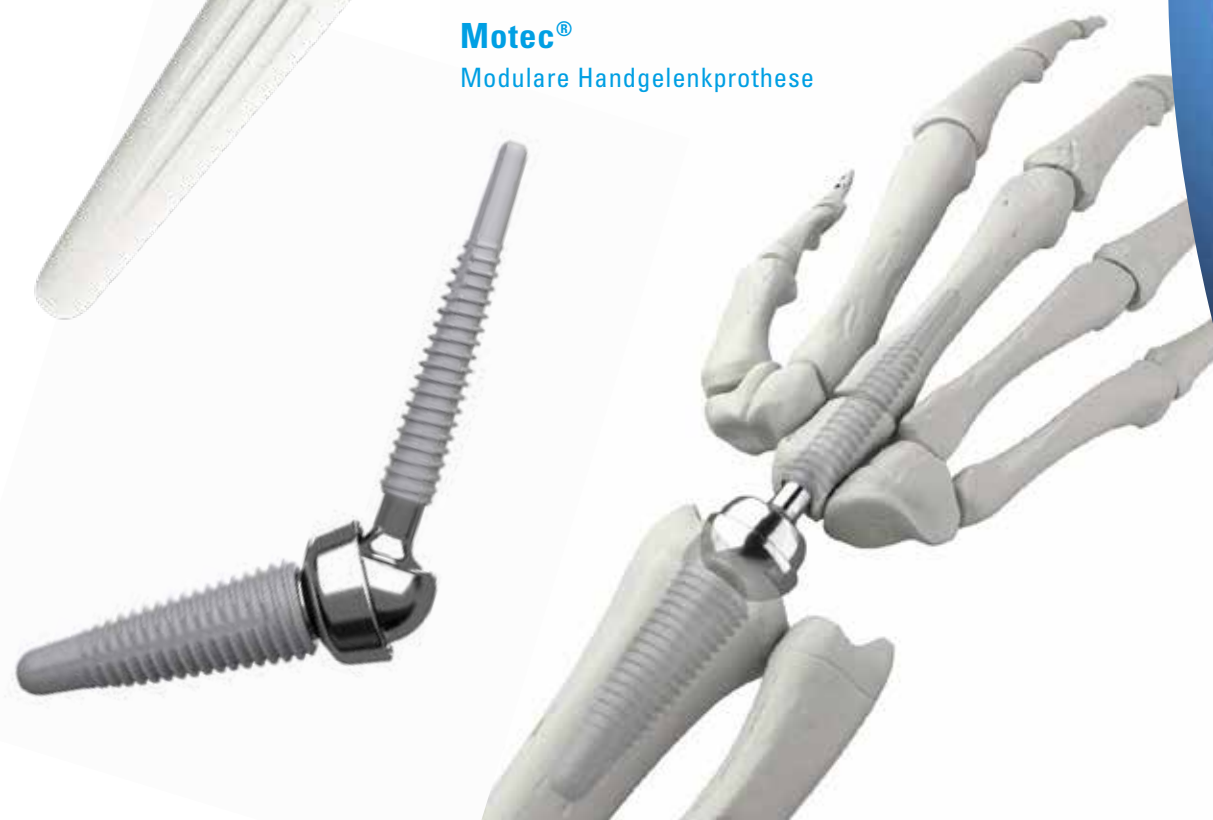





### KeriFlex®

Fingergelenk-Implantate  
PIP - MCP aus Silikon

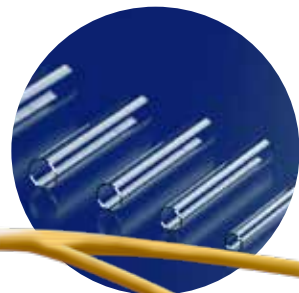

### Reaxon® Direct

Unterstützung der Nervenregeneration

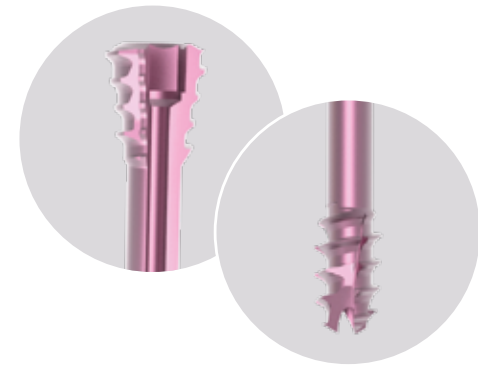

### Handmotion



### Initial S™ Hand

Kanülierte Schrauben mit steriliem  
Einweg-Instrumenten Kit



**KeriFuse®**  
Intramedulläres  
Arthrodesenimplantat DIP - IP



**KeriFix®**  
Einschlag-Anker



**KeriLock®**  
Schraubanker



### Kemis®

Einwegmesser für verschiedene  
minimalinvasive Chirurgie (MIS)





NEWCLIP-TECHNICS



**Initial R™ Xpert 2.4**  
Volare Platten für distalen Radius



Patientenspezifische  
Schnittblöcke für  
den distalen Radius



NEWCLIP-TECHNICS



**Alians Ulna 3/3**  
Verkürzungsosteotomie der Ulna

**Alians Fragment Specific**  
Fragmentspezifische Platten





**ORTHOFIX**  
ORTHOPEDICS



### RadioLuscent

Wrist Fixator

Steriler Handgelenkfixateur



### M2

MultiPlanar MiniRail® System

**APTIS**

### Scheker

Distale Radio-Ulnar-  
Gelenkprothese

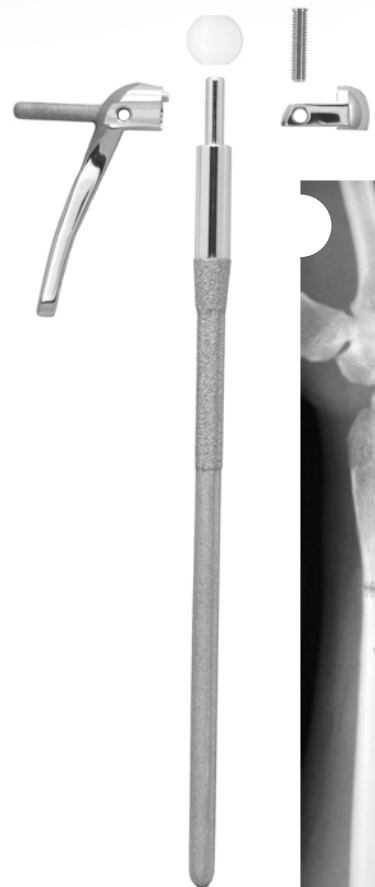

**miCUTec**  
The power of minimally invasive surgery

### miCUTone®

Motor mit sterilen  
Einweg Handstücken

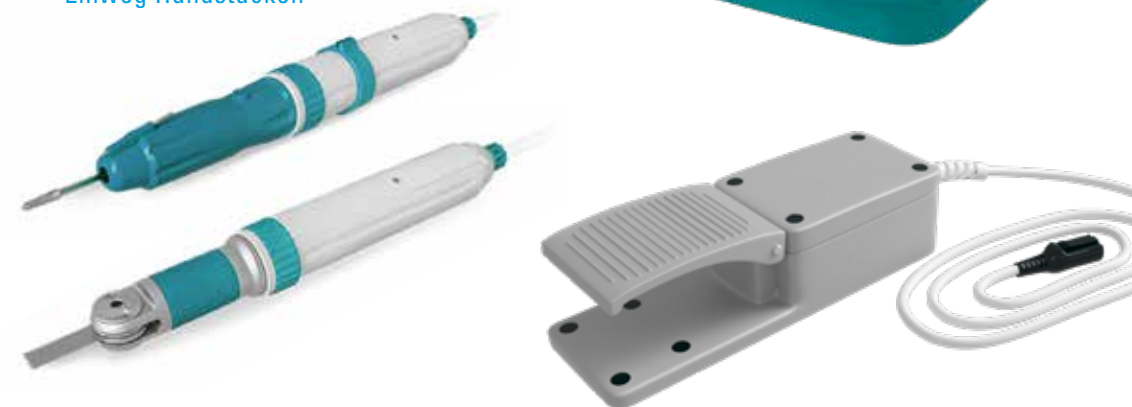

NEWCLIP-TECHNICS



Perkutane Fräsen

**ORTHOFIX**  
ORTHOPEDICS

### Calcaneal

External Fixator





NEWCLIP-TECHNICS



### Initial S™ Foot

Kanülierte Schrauben mit sterilen Einweg-Instrumenten Kit



### Footmotion

Vorfuss

Komplettes Schraubensortiment



### Arthrodesenklammern in verschiedenen Grössen



NEWCLIP-TECHNICS



### Initial A™

Fibula Einweg-Kit

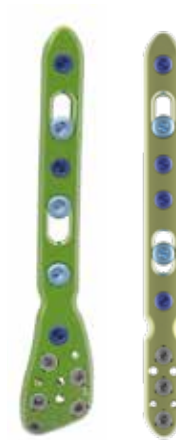

### Initial F™ MTP

MTP1 Einweg-Kit





NEWCLIP-TECHNICS



### Footmotion

Plattensystem

Vollständiges Sortiment an Platten für die Chirurgie des Vor- und Mittelfusses



Plantar Lapidus



Flatfoot



### ACTIV FUSE

Sprunggelenk-Arthrodesese

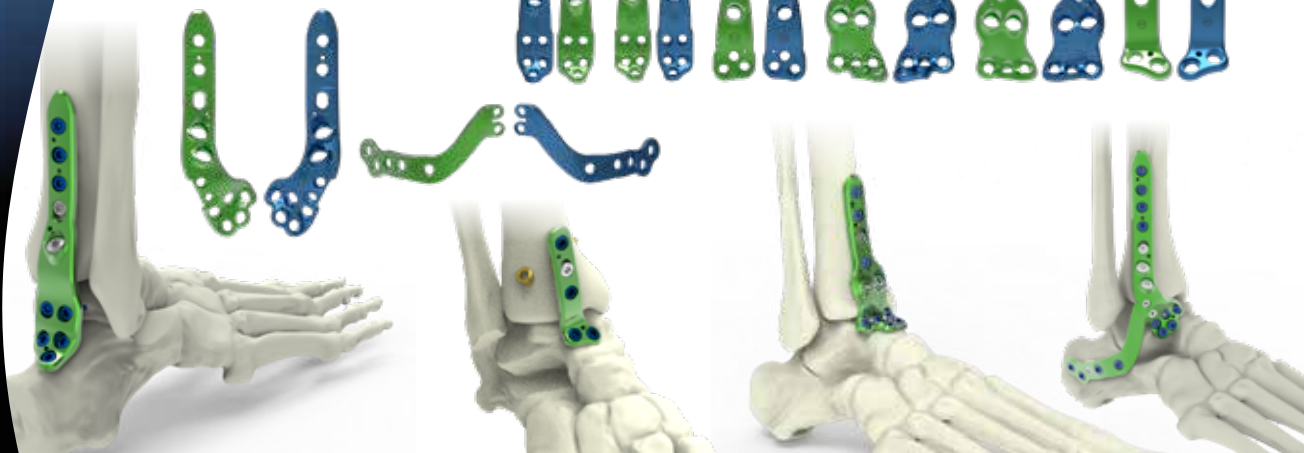

NEWCLIP-TECHNICS



### Activmotion S

Aufklappende Tibiaosteotomie



### Activmotion S

Platten für medial oder lateral zuklappende Tibiaosteotomie



### Activmotion S

Aufklappende und zuklappende Femurosteotomie



### Activmotion S Ligamento

Osteotomieplatten für zusätzliche Kreuzbander-konstruktion



Patientenspezifische Schnittblöcke für Femur und Tibia







**ORTHOFIX**  
ORTHOPEDICS



### Galaxy Fixation™

Gemini™ System

Fixateur extern mit modularem Befestigungssystem



### Galaxy Unyco™

System

Monokortikaler Aufsatz für Damage Control



### Galaxy Fixation™

Elbow System

Einweg-Kit



**ORTHOFIX**  
ORTHOPEDICS



### TrueLok™

Ring Fixation System

Externer Ringfixateur



### TL-HEX

TrueLok Hexapod System®



### TL-HEX Trauma

TrueLok Hexapod System®

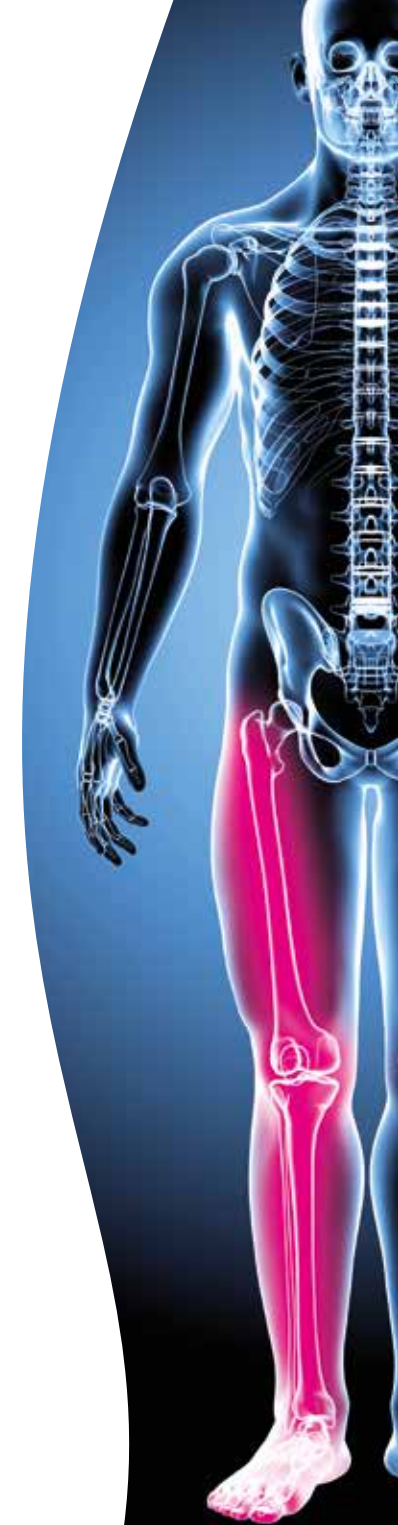





**ORTHOFIX**  
ORTHOPEDICS

### Chimaera

Hip Fracture System\*

Hüftfraktursystem  
Trochantärer Nagel



### Oscar Pro™

System

Ultraschallinstrument zur  
Revision von Endoprothesen



### Fitbone

Intramedullary Lengthening System

Verlängerungsmarknagel



**ORTHOFIX**  
ORTHOPEDICS



**XCaliber™**  
Fixator



**XCaliber™**  
Meta-Diaphyseal Fixator



### LRS

Limb Reconstruction System™

### XCaliber™

Articulated Ankle Fixator

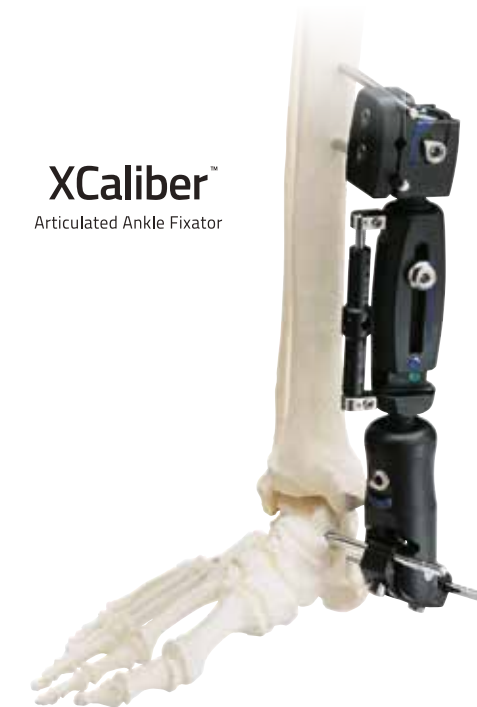



NEWCLIP-TECHNICS



### Alians Ellenbogen

Platten für proximale Ulna oder distalen Humerus



### HYLA

Hybrid Latarjet



### Alians Clavicula

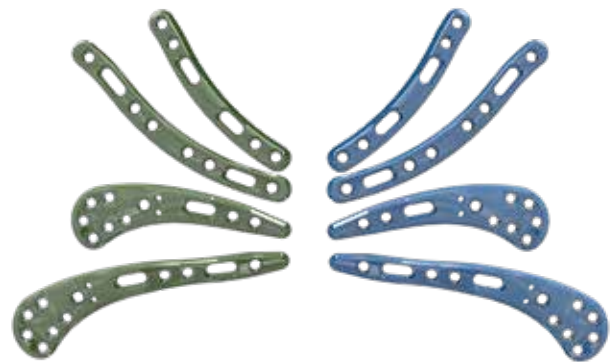

**ORTHOFIX**  
ORTHOPEDICS

### LRS

Limb Reconstruction System™

Paediatric



### MJ-Flex

The New Metaizeau Nail™



### Eight-Plate

Guided Growth System®

### Galaxy Fixation

System

Steriles Set für Kinder



### Rodeo

Telescopic Nail







maxxeus™



**Allogene Knochentransplantate**  
Verschiedene Formate

**DBM**  
Fiber, Putty, Schwamm



bonalive

**Bonalive® granules**

Bioaktives synthetisches Glas für Knochenregeneration. Resorbierbar, Osteokonditiv und Bakterio-statisch.

**Bonalive® putty\***

Bioaktives synthetisches Glas für Knochenregeneration. Resorbierbar, Osteokonditiv, osteostimulierend.







**ActivaPin™**  
**ActivaNail™**  
**ActivaScrew™**  
 Bioresorbierbar

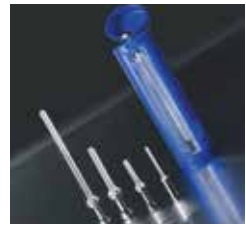

**Activa IM-Nail™**  
 Bioresorbierbarer und  
 intramedullärer Nagel



**Wiederverwendbarer Bohrer**

Modular

Monobloc

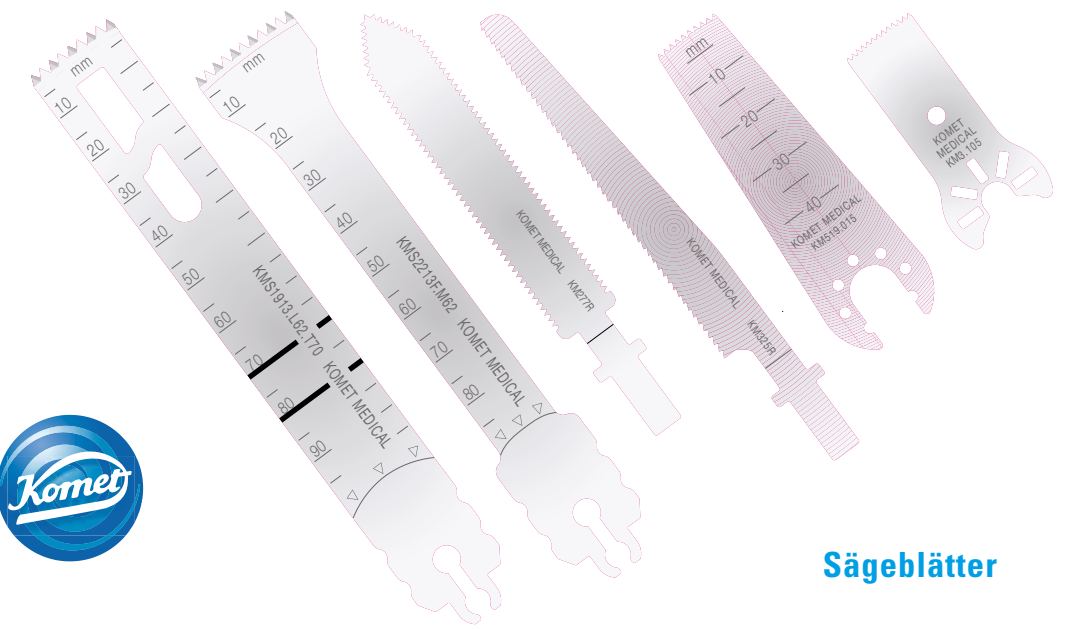

**Sägeblätter**







**Anjon Bremer® Halo System**  
Superiore Halswirbelsäulenstütze

**Anjon**  
Medical Technologies



**Kirschnerdrähte und Steinmann-Nagel**

**Cerclage-Draht**



**Spickdrahträger**



**Spickdrahröhre / Behälter**

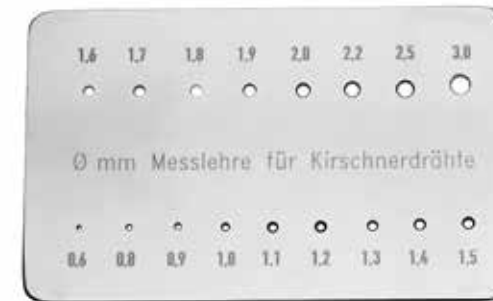

**Schablone**

**Zentimetermass**

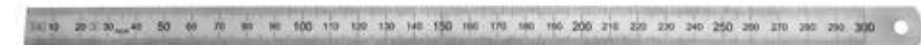



Steriler dünner  
Stift mit Lineal

### Sterile Hautstifte

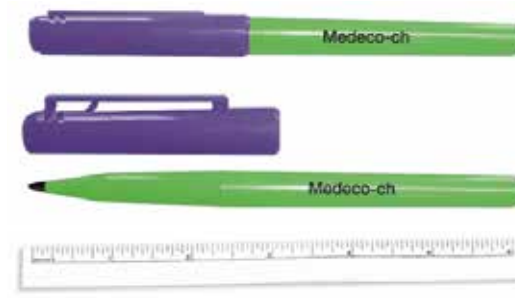

Steriler Standardstift  
mit Lineal

### Sterile Etiketten und Permanentstift

<b>Bacitracin</b> Amt _____ Exp _____
<b>Cocaine _____ %</b> Amt _____ Exp _____
<b>DYE</b> Amt _____ Exp _____
<b>Epinephrine</b> Amt _____ Exp _____
<b>Heparin _____ units</b> Amt _____ Exp _____
<b>Heparinized Saline</b> _____ units/ml Amt _____ Exp _____



Personalisiert

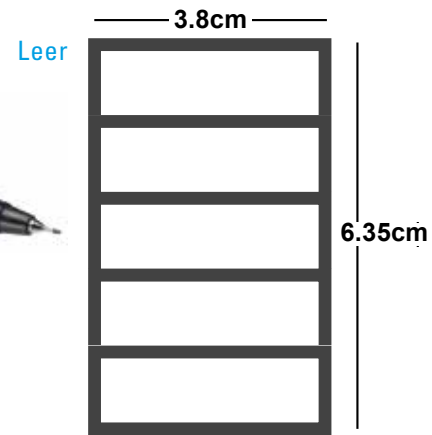

Verschiedene Modelle vorrätig. Kontaktieren Sie uns für mehr Informationen.

Besuchen Sie unsere Website für weitere Informationen:  
[www.medeco-ch.com](http://www.medeco-ch.com)





## Medeco-ch:

### Ein telefonischer Informationsdienst

steht Ihnen 24 Stunden täglich zur Verfügung.  
Unter der folgenden Telefonnummer werden alle  
Ihre Fragen beantwortet: +41 79 434 91 60

### Sie haben drei Möglichkeiten zur Bestellung:

- **telefonisch:** +41 22 307 01 70
- **per Fax:** +41 22 362 11 85
- **per E-Mail:** [info@medeco-ch.com](mailto:info@medeco-ch.com)

Alle bis 17 Uhr eingegangenen Bestellungen  
können, je nach Lagerverfügbarkeit, auf den  
darauffolgenden Tag geliefert werden.

Medeco-ch Sàrl  
Route de Trélex 8  
1266 Duillier  
Schweiz  
Telefon: +41 22 307 01 70  
Fax: +41 22 362 11 85  
[info@medeco-ch.com](mailto:info@medeco-ch.com)  
[www.medeco-ch.com](http://www.medeco-ch.com)

# Ihre Zufriedenheit ist unsere Motivation