

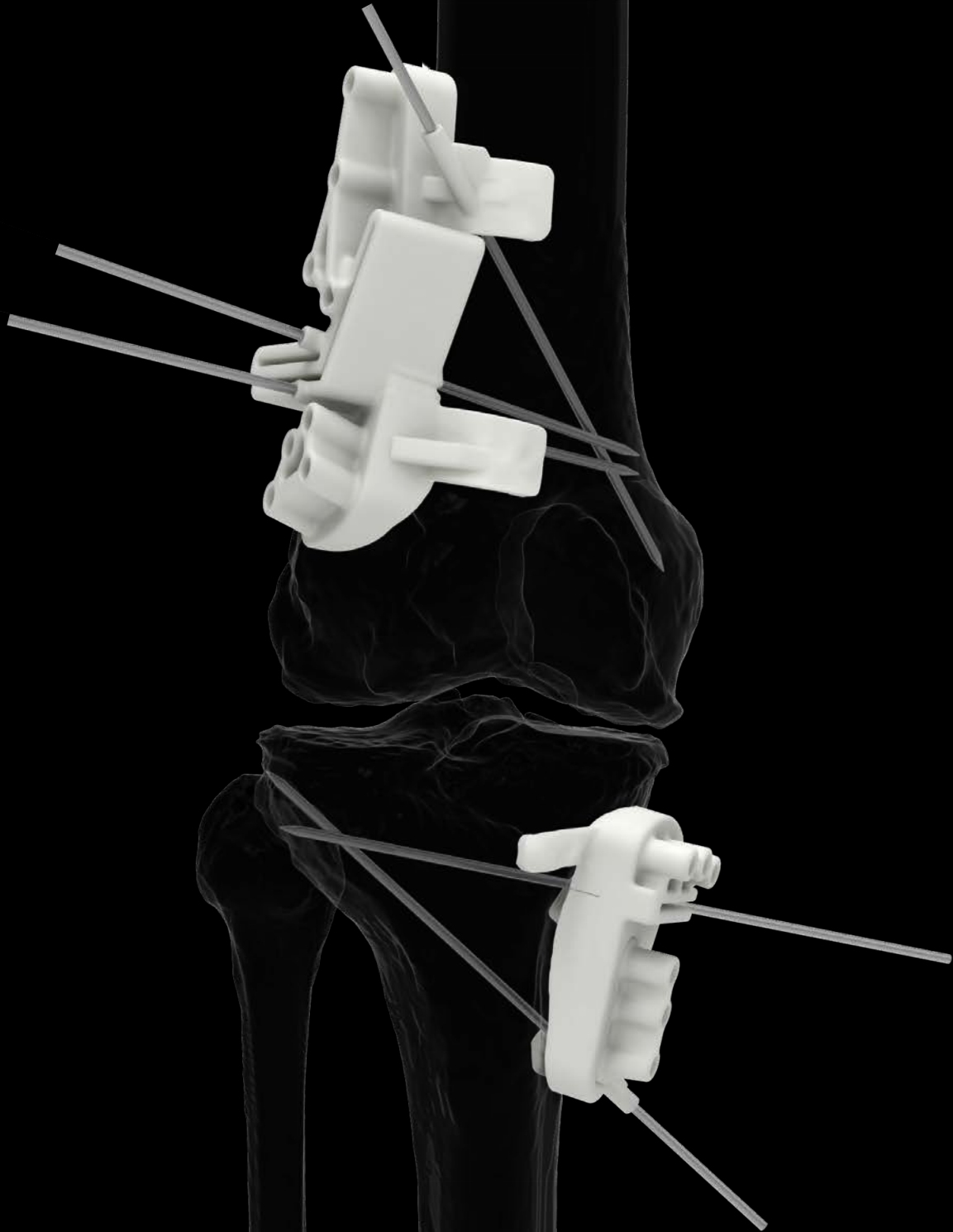

NEWCLIP
TECHNICS



PSI SOLUTION

PATIENT-MATCHED CUTTING GUIDES

ONE

PSI SOLUTION WITH ACTIVMOTION S

Intended purpose: The implants of the Activmotion S range are intended for knee osteotomy in adults. The patient-matched cutting guides are intended for measuring anatomical parameters, fixing instruments or implants, and guiding instruments.

Contraindications:

- Pregnancy.
- Acute or chronic local or systemic infections.
- Allergy to one of the materials used or sensitivity to foreign bodies.

GET THE FULL PICTURE

FEMORAL CLOSING AND DEROTATION PLATES



FEMORAL OPENING PLATES



TIBIAL OPENING PLATES



DEFLEXION PLATES



TIBIAL CLOSING PLATES



N.B.: Some of the patient-matched cutting guides and/or implants may not be available depending on your country.

TECHNICAL FEATURES

PATIENT-MATCHED CUTTING GUIDE

The PSI solution is based on the CT scan of the patient and allows a correction of the knee in the three planes.

FEMORAL GUIDE

Example of a femoral guide vvvv

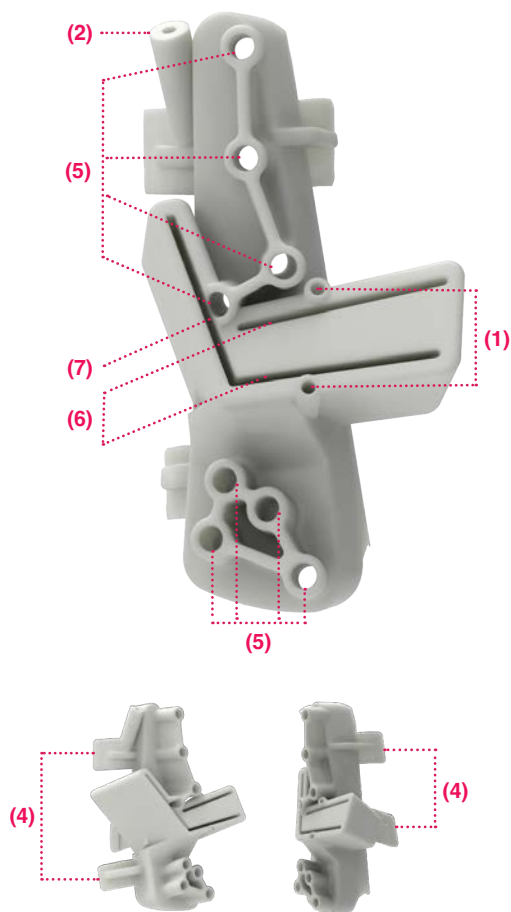

TIBIAL GUIDE

Example of a tibial guide associated to the ATxP2D plate

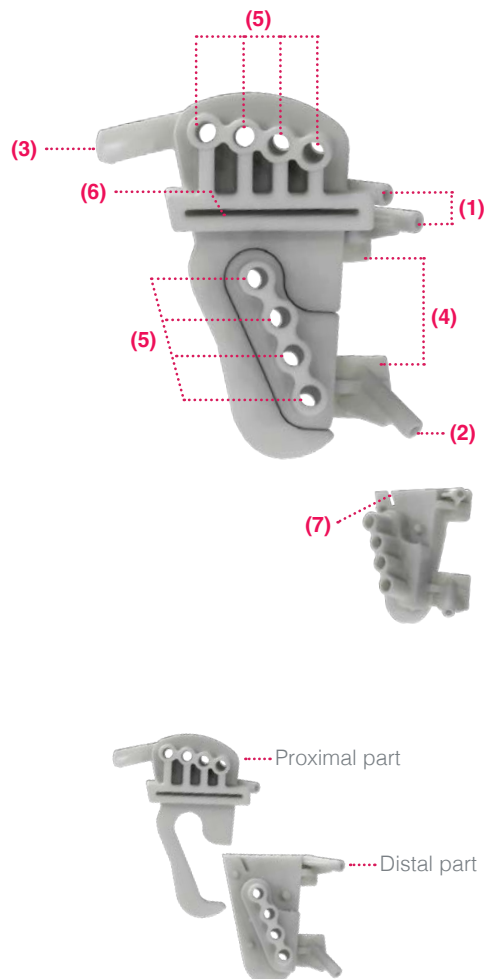

1. The «**cutting K-wire(s)**» allow(s):
 - to verify the direction of the cut(s);
 - to visualize the bone wedge to remove;
 - to confirm the position of the patient-matched cutting guide.
2. The «**hinge K-wire(s)**» allow(s):
 - to stop the cut;
 - to protect the hinge during the opening;
 - to confirm the position of the patient-matched cutting guide;
 - to visualize the location and thickness of the hinge.
3. The **anterior bracket** is positioned under the patellar tendon in line with its insertion.
4. The **brackets are congruent** with the surface of the bone and allow a better positioning of the patient-matched cutting guide.
5. **Drill guides**, when the holes of the bone will align with the holes of the plate, the desired correction will be achieved in the three planes.
6. Patient-matched cutting guide slot adapted to the surgeon's **sawblade**.
7. Patient-matched cutting guide slot for the **biplanar cut**.

TECHNICAL FEATURES

PATIENT-MATCHED CUTTING GUIDE - OPTIONS

The options shown are available on request and **must be selected** when creating a case on the dedicated portal.

TUNNEL FOR LIGAMENTOPLASTY

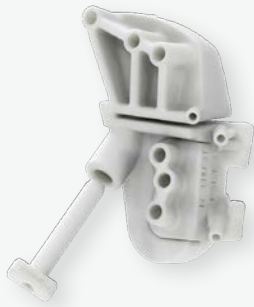

PATIENT-MATCHED WEDGE



ATT GUIDE



MEASURES

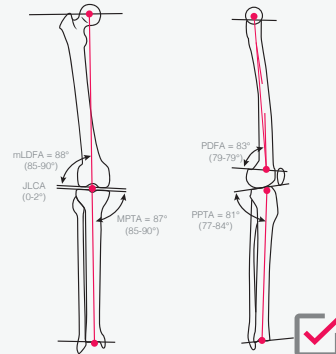

FEMORAL HEAD CUTTING GUIDE*



ILIAC CREST CUTTING GUIDE*



BONE SUBSTITUTE CUTTING GUIDE*

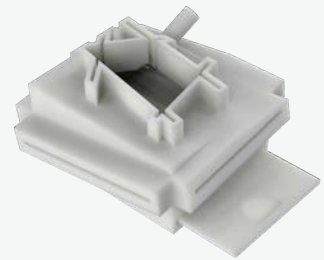

N.B.: Some of the patient-matched cutting guides options may not be available depending on your country.

* For more information see the brochure **PSI - Graft cutting options**

THE ADVANTAGES OF THE PSI SOLUTION

PRECISION & REPEATABILITY OF THE CORRECTION

The PSI solution allows to perform a precise correction. The solution includes in its design the correction that will be applied and the position of the plate at its optimized position.

How is created the patient-matched cutting guide to ensure the precision of the correction on all the planes?

STEP 1 : WANTED CORRECTION APPLIED ON THE PREOPERATIVE BONE



STEP 2 : PLATE APPLIED AT ITS OPTIMIZED POSITION



STEP 3 : HOLES OF THE PLATE SIMULATED ON THE POSTOPERATIVE BONE



STEP 4 : PLATE REMOVED



STEP 5 : RETRO-ENGINEERING : BONE POSITIONED IN THE PREOPERATIVE CONFIGURATION



STEP 6 : PATIENT MATCHED CUTTING GUIDE DESIGNED



SAFETY

The PSI solution brings safety to the key steps of your surgical procedure.

- The hinge K-wire allows:
 - To stop the sawblade;
 - To preserve the hinge thickness;
 - To limit the risk of hinge fracture during opening.
- Protection of the patellar tendon.
- Secure the position of the plate and screws.



THE ADVANTAGES OF THE PSI SOLUTION

TIME SAVING IN THE OPERATING ROOM

The PSI solution allows to decrease the time of surgery:

- Surgical technique already validated
- Position of the plate pre-established
- Screws lengths already calculated

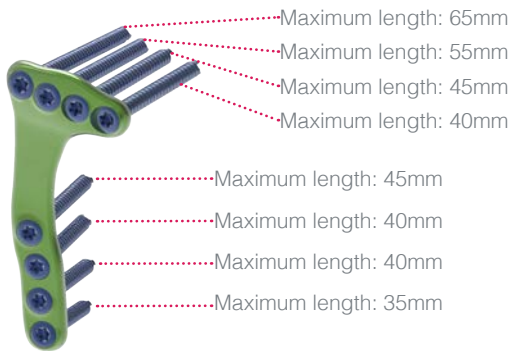

Example of information on the patient-matched surgical technique



REDUCTION OF THE NUMBER OF FLUOROSCOPY SHOTS

The PSI solution allows to reduce the number of fluoroscopy shots during surgery. They are only necessary to validate the position of the patient-matched cutting guide and to validate the final assembly.

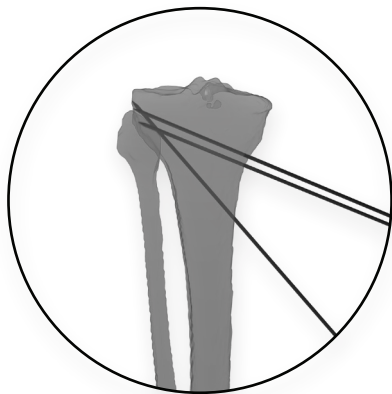

FOR ALL KIND OF SURGERY

The PSI solution allows to manage classic cases routinely, as well as to deal with complex surgeries.



Derotation

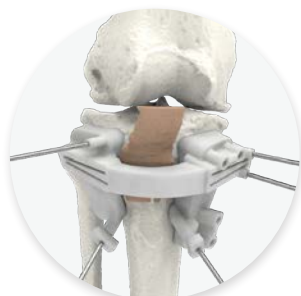

Slope change



HTO with ligamentoplasty

NEWCLIP PSI PROCESS

HOW TO START THE PSI PROCESS ?

To start the process for a patient-matched cutting guide, you should give the information below:

- CT Scan (see Newclip protocol)
- Type of surgery
- Operative side
- Date of surgery
- Type of Plate
- Additional options

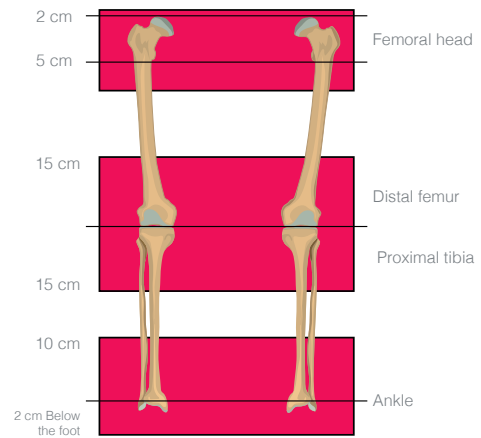

CT scan protocol

STEPS OF THE PSI PROCESS

FROM CT SCAN TO SURGERY IN MINIMUM 25 WORKING DAYS

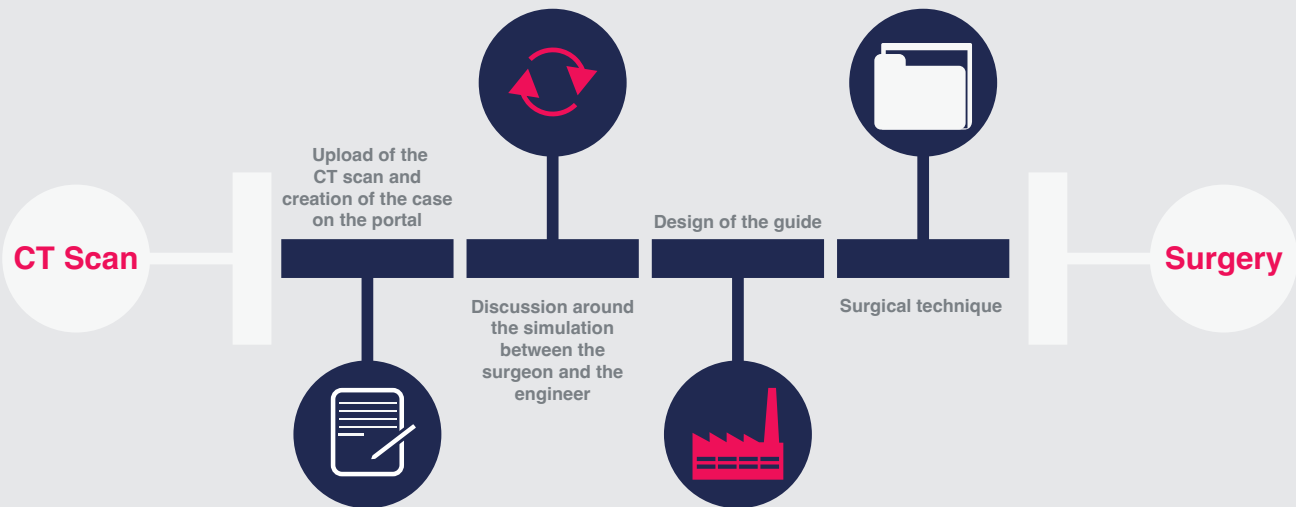

A DEDICATED PORTAL

WHY A WEB PORTAL ?

- To request patient-matched cutting guides;
- To exchange documents (Medical imaging, patient-matched surgical technique, simulation file...);
- To follow the process;
- To communicate about the case.



In accordance with the personal data protection laws, the Provider will do its best efforts to take all useful precautions, in particular with regards to the nature of the Personal Data and the risks of the processing, to preserve the security and confidentiality of the Personal Data transmitted, processed or stored and to prevent their distortion, alteration, damage, accidental or unlawful destruction, loss disclosure and/or access by third parties not previously authorized.

SURGICAL TECHNIQUE

MOWHTO WITH BIPLANAR CUT - GUIDE POSITIONING (STEP 1/3)

The following surgical technique illustrates the Activmotion S medial opening wedge high tibial osteotomy plate size 1 (ATxP1D). The same steps apply to the Activmotion S medial opening wedge high tibial osteotomy plate size 2 (ATxP2D).



1. Guide positioning

Position the patient-matched (PM) cutting guide (ANC656) on the antero-medial surface of the tibia using the congruence of the PM cutting guide and the anterior and medial brackets.

Caution: Please do not modify the insertion of the patellar tendon.



2. «Cutting K-wire» insertion

Insert a Ø2.2 mm K-wire (33.0222.200) in the «cutting K-wire» hole positioned on the medio-proximal bracket.

To check the insertion depth, measure the part of the K-wire remaining out of the hole and compare it to the one mentioned in the PM surgical technique.

OPTION - STEP 3 BIS

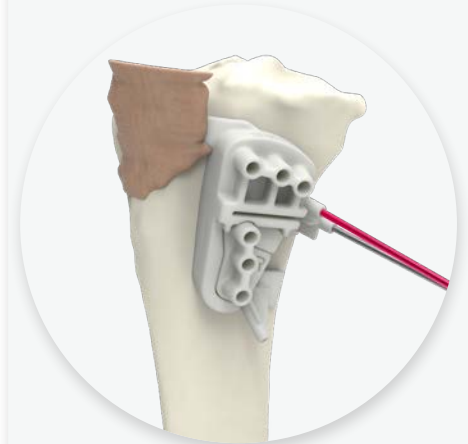

Optional second «cutting K-wire»

A second Ø2.2 mm K-wire (33.0222.200) can be inserted above the first one. It will secure the sawblade path.

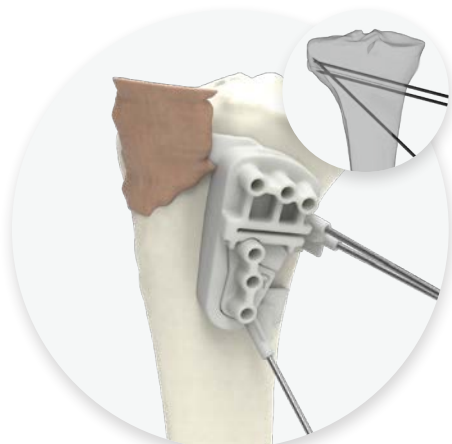

3. «Hinge K-wire» insertion

Insert a Ø2.2 mm K-wire (33.0222.200) in the «hinge K-wire» hole positioned on the medio-distal bracket.

To check the insertion depth, measure the part of the K-wire remaining out of the hole and compare it to the one mentioned in the PM surgical technique.

Check the position of the PM cutting guide by comparing the fluoroscopy shot with the PM surgical technique.

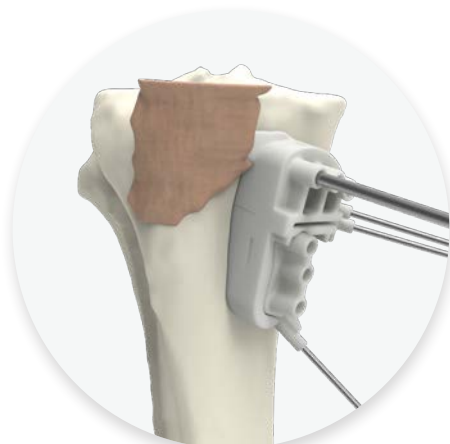

4. Drill the holes

Drill bicortically with the Ø4.0 mm drill bit (ANC211) through the 3 distal holes of the PM cutting guide (4 holes for the ATxP2D) and monocortically (ANC211) through the 3 proximal holes (4 holes for the ATxP2D).



5. Fixation pins insertion

Insert four long pins (ANC657), two in the proximal part of the PM cutting guide and two distal, by using a mallet.

SURGICAL TECHNIQUE

MOWHTO WITH BIPLANAR CUT - CUTTING (STEP 2/3)



6. Initiate the cut

Insert the sawblade in the PM cutting guide slot and initiate the cut in the antero-posterior direction.



7. Remove the proximal part of the PM cutting guide

Remove the proximal long pins (ANC657) and the second «cutting K-wire» (33.0222.200).

Then remove the proximal part of the PM cutting guide (ANC656).



8a. Finalize the cut

Reinsert the sawblade and finalize the cut in medio-lateral direction.

Once the sawblade reaches the «hinge K-wire», the cut is complete.

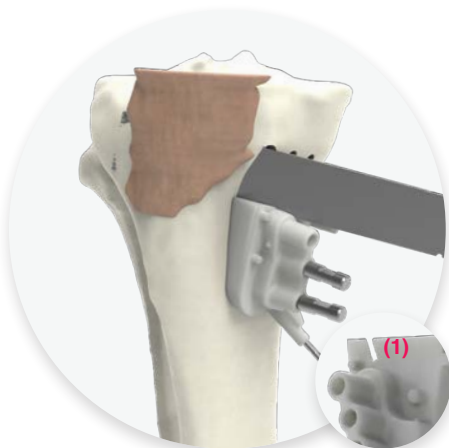

8b. Biplanar cut

Insert the sawblade in the biplanar slot (1). The cut must be bicortical.



9. Remove the distal part of the PM cutting guide

Remove the distal long pin (ANC657) and the «cutting K-wire» (33.0222.200). Then remove the distal part of the PM cutting guide (ANC656) by sliding it over the «hinge K-wire».



10. Perform the opening

Insert a patient-matched wedge (ANC956) or a metallic wedge for knee osteotomy (ANC019 to ANC023 and ANC025), to perform the opening.

The patient-matched wedge is an option and **must be selected** when the case is uploaded on the portal.

SURGICAL TECHNIQUE

MOWHTO WITH BIPLANAR CUT - PLATE FIXATION (STEP 3/3)



11a. Plate positioning

Insert two short pins (ANC774) into the two distal holes of the plate.



11b. Plate positioning

The planned osteotomy is reached when the holes of the bone are facing the holes of the plate. Insert two short pins (ANC774) in the most lateral and the most medial hole.



12. Plate fixation

Press the plate against the bone and use the countersink (ANC120-US) to prepare the first cortical of the two remaining holes.



ANC120-US

Insert two locking screws (ST4.5LxxD) using the screwdriver (ANC975) without locking them.



ANC975

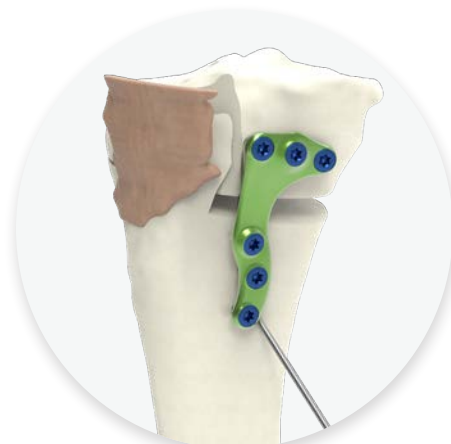

13. Finalize the assembly

Finalize the assembly by inserting the remaining Ø4.5 mm locking screws (ST4.5LxxD).

A screw must be inserted right after removing a short pin (ANC774).

Proceed by inserting alternatively proximal and distal screws getting further and further away from the osteotomy site. Use the countersink (ANC120-US) to prepare the first cortical.

Then, remove patient-matched wedge (ANC956).



14. FINAL RESULT

Remove the hinge K-wire (33.0222.200).

SURGICAL TECHNIQUE

ACL TUNNEL OPTION *

* The ligamentoplasty tunnel is an option and must be selected when the case is uploaded on the portal.

The following surgical technique illustrates the Activmotion S medial opening wedge high tibial osteotomy with ligamentoplasty plate (ALTxP1D). The same steps apply to the Activmotion S opening wedge high tibial osteotomy with ligamentoplasty and suture button plate (AETxP1D).

The surgical technique for a MOWHTO with ligamentoplasty follows the same first steps as the MOWHTO surgical technique from 1 through to 6 (see pages 8 and 9).

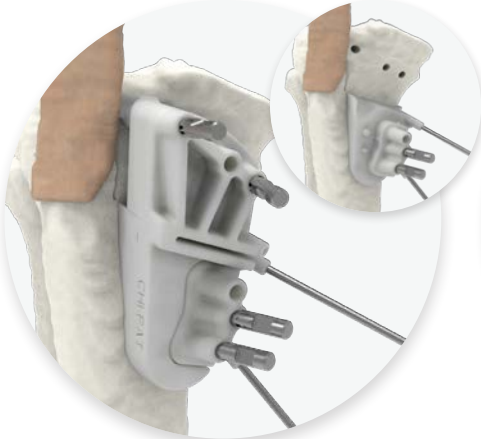

7a. Remove the proximal part of the patient-matched cutting guide

Remove the proximal long pins (ANC657). Then remove the proximal part of the patient-matched (PM) cutting guide (ANC656).

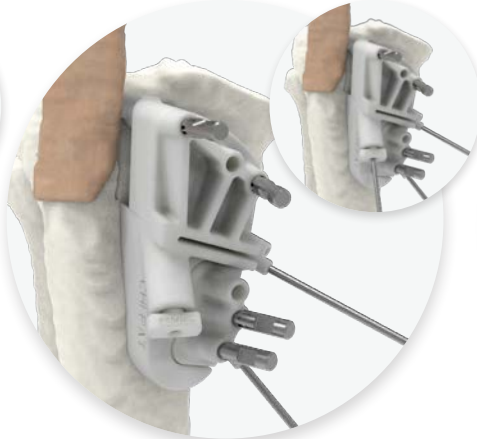

7b. Position the second proximal part of the PM cutting guide

Position the second proximal part of the PM cutting guide (ANC656) with the ACL tunnel and fix it with long pins (ANC657). Insert the holding plot (ANC1350) and a Ø2.2 mm K-wire (33.0222.200) into it.

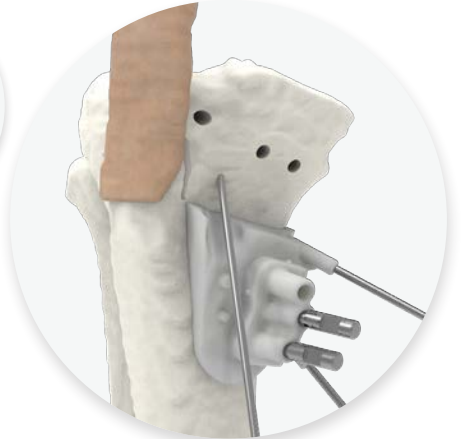

7c. Remove the second proximal part of the PM cutting guide

Remove the proximal long pins (ANC657), the holding plot (ANC1350) and then remove the second proximal part of the PM cutting guide (ANC656) by sliding it over the ligamentoplasty K-wire.

The next steps of the surgical technique for a MOWHTO with ligamentoplasty, follow the same steps as the MOWHTO surgical technique from 8 to 13 (see pages 9 and 10).



13. Finalize the assembly

Finalize the assembly by inserting the remaining Ø4.5 mm locking screws (ST4.5LxxD).

A screw must be inserted right after removing a short pin (ANC774).

Proceed by inserting alternatively proximal and distal screws getting further and further away from the osteotomy site. Use the countersink (ANC120-US) to prepare the first cortical.

Remove the patient-matched wedge (ANC956).



14. FINAL RESULT

Remove the hinge K-wire (33.0222.200).

With the help of the ligamentoplasty K-wire (33.0222.200) previously placed, perform the ACL tunnel with your standard instruments.

SURGICAL TECHNIQUE

MCWHTO - GUIDE POSITIONING (STEP 1/3)

The following surgical technique illustrate the Activmotion S medial closing wedge high tibial osteotomy plate size 2 (BTxMD2D). The same steps apply to the Activmotion S medial closing wedge high tibial osteotomy size 1 (BTxMD1D), and to the Activmotion S lateral closing wedge high tibial osteotomy size 1 (BTxBD1D) and size 2 (BTxBD2D).



1. Guide positioning

Position the patient-matched (PM) cutting guide (ANC656) on the antero-medial surface (lateral surface for the lateral closing wedge) of the tibia using the congruence of the PM cutting guide and the anterior and medial brackets.

Caution: Please do not modify the insertion of the patellar tendon.

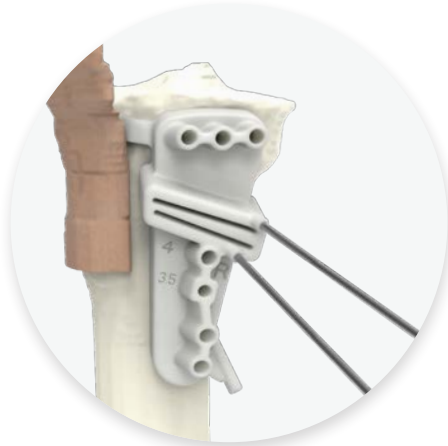

2. «Cutting K-wires» insertion

Insert the Ø2.2 mm K-wires (33.0222.200) in the «cutting K-wire» holes.

To check the insertion depth, measure the part of the K-wire remaining out of the hole and compare it to the one mentioned in the PM surgical technique.

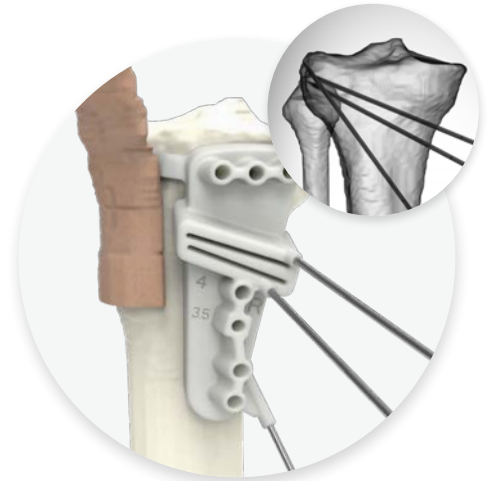

3. «Hinge K-wire» insertion

Insert the Ø2.2 mm K-wire (33.0222.200) in the «hinge K-wire» hole.

To check the insertion depth, measure the part of the K-wire remaining out of the hole and compare it to the one mentioned in the PM surgical technique.

Check the position of the PM cutting guide by comparing the fluoroscopy shot with the PM surgical technique.



4a. Drill the Ø4.0 holes

Drill bicortically with the Ø4.0 mm drill bit (ANC211) through the 3 distal round shape holes (3 holes for the BTxBD2D, and 1 hole for the size 1 BTxMD1D and BTxBD1D), and monocortically (ANC211) through the 3 proximal holes (3 holes for the BTxBD2D) and 2 holes for the size 1 BTxMD1D and BTxBD1D).

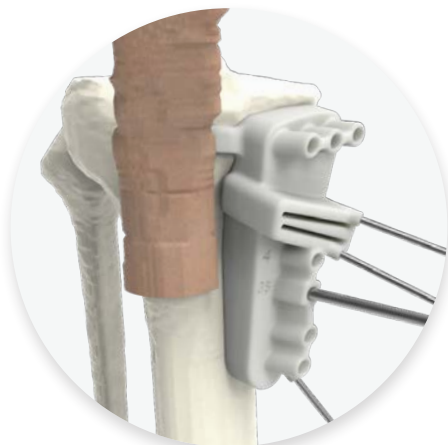

4b. Drill the Ø3.5 holes

Drill bicortically with the Ø3.5 mm drill bit (ANC1075) through the 1 distal square shape hole (1 distal square shape hole with the BTxMD1D, BTxBD2D and BTxBD1D).



5. Fixation pins insertion

Insert four long pins (ANC657), two in the proximal part of the PM cutting guide and two in the most distal holes (two for the BTxBD2D but only 1 in distal for the size 1 BTxMD1D and BTxBD1D), by using a mallet.

SURGICAL TECHNIQUE

MCWHTO - CUTTING (STEP 2/3)



6a. Initiate the cuts

Insert the sawblade in the distal PM cutting guide slot and initiate the cut.



6b. Initiate the cuts

Insert the sawblade in the proximal PM cutting guide slot and initiate the cut.



7. Remove the PM cutting guide

Remove the long pin (ANC657) and the «cutting K-wires» (33.0222.200). Then remove the PM cutting guide (ANC656) by sliding it over the «hinge K-wire».



8. Finalize the cuts

Reinsert the sawblade in the previous cuts and finalize the cuts.

Once the sawblade reaches the «hinge K-wire», the cuts are complete.



9. Remove the bone wedge

Remove the bone wedge cut and remove the «hinge K-wire» (33.0222.200).

SURGICAL TECHNIQUE

MCWHTO - PLATE FIXATION (STEP 3/3)



10a. Plate positioning

Insert two short pins (ANC774) into the two distal holes of the plate (2 for the BTxBD2D and 1 for the size 1 BTxMD1D and BTxBD1D).



10b. Plate positioning

The planned closing is reached when the holes of the bone are facing the holes of the plate. Insert two short pins (ANC774) in the most lateral and most medial hole.



11. Plate fixation

Press the plate against the bone and use the countersink (ANC120-US) to prepare the first cortical of the two remaining holes.



ANC120-US

Insert two locking screws (ST4.5LxD) using the screwdriver (ANC975) without locking them.



ANC975

Insert the Ø4.5 mm non-locking screw (CT4.5LxD-ST) using the screwdriver (ANC975) in the ramp oblong hole.



12. FINAL RESULT

Finalize the assembly by inserting the remaining Ø4.5 mm locking screws (ST4.5LxD).

A screw must be inserted right after removing a short pin (ANC774).

Proceed by inserted alternatively proximal and distal screws getting further and further away from the osteotomy site. Use the countersink (ANC120-US) to prepare the first cortical.

SURGICAL TECHNIQUE

ACWHTO SUPRA-TUBERCLE - GUIDE POSITIONING (STEP 1/3)

The following surgical technique illustrate the Activmotion S anterior closing wedge high tibial osteotomy plate size 1 (BATxMD1D) with a supra-tubercle technique.



1. Guide positioning

Position the patient-matched (PM) cutting guide (ANC656) on the anterior surface of the tibia using the congruence of the PM cutting guide.

Caution: Please do not modify the insertion of the patellar tendon.

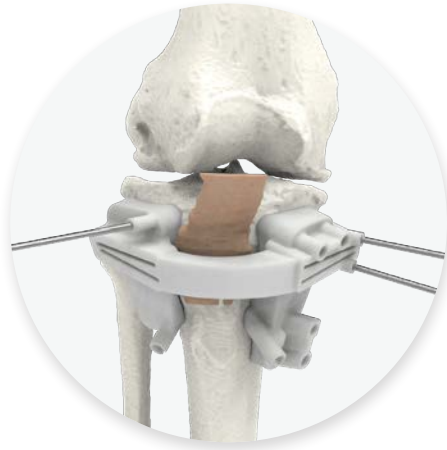

2. «Cutting K-wires» and «positioning K-wire» insertion

Insert a Ø2.2 mm K-wire (33.0222.200) in the «cutting K-wire» holes and in the «positioning K-wire » hole.

To check the insertion depth, measure the part of the K-wire remaining out of the hole and compare it to the one mentioned in the PM surgical technique.

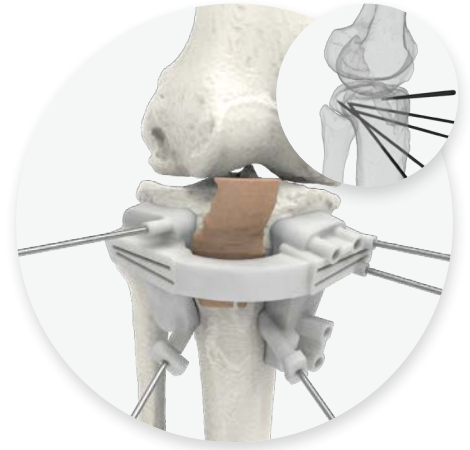

3. «Hinge K-wires» insertion

Insert the holding plots (ANC1350) in the «hinge K-wire» holes and then a hinge K-wire (33.0222.200) into it.

To check the insertion depth, measure the part of the K-wire remaining out of the hole and compare it to the one mentioned in the PM surgical technique.

Check the position of the PM cutting guide by comparing the fluoroscopy shot with the PM surgical technique.

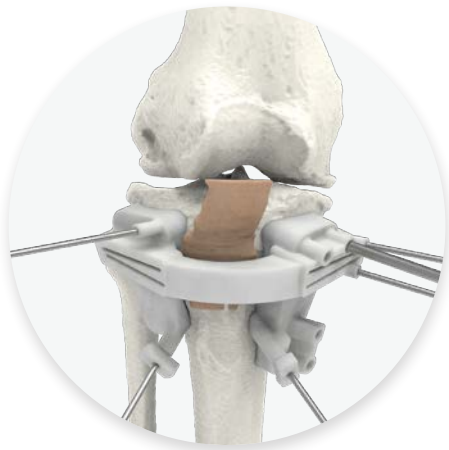

4a. Drill the Ø 4.0mm holes

Drill monocortically with the Ø4.0 mm drill bit (ANC211) through the proximal holes of the PM cutting guide and bicortically (ANC211) through the round shape distal hole.



4b. Drill the Ø 3.5mm holes

Drill bicortically with the Ø3.5 mm quick coupling drill bit (ANC1075) through the square shape distal hole.



5. Fixation pins insertion

Insert three long pins (ANC657), two in the proximal part of the PM cutting guide and one in the distal hole, by using a mallet.

SURGICAL TECHNIQUE

ACWHTO SUPRA-TUBERCLE - CUTTING (STEP 2/3)



6a. Initiate the cut

Insert the sawblade in the PM cutting guide slots in the medial part of the PM cutting guide and initiate the cut.

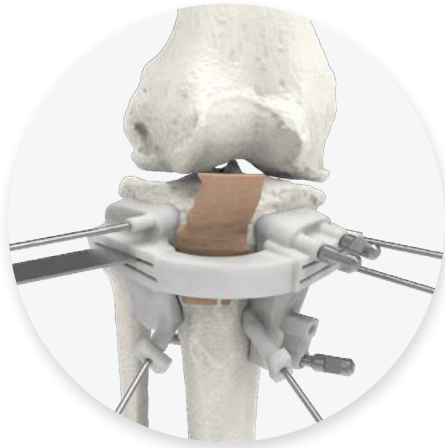

6b. Initiate the cut

Insert the sawblade in the PM cutting guide slots in the lateral part of the PM cutting guide and initiate the cut.



7. Remove the PM cutting guide

Remove the long pins (ANC657), the «cutting K-wires» (33.0222.200), «the positioning K-wire» (33.0222.200) and the holding plots (ANC1350).

Then remove the PM cutting guide (ANC656) by sliding it over the «hinge K-wires».

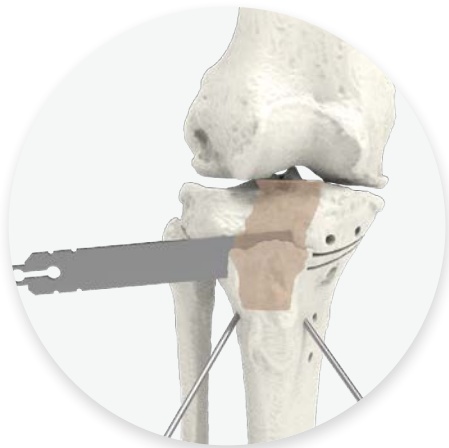

8. Finalize the cut

Realize the biplanar cut by hand. Reinsert the sawblade and finalize the cuts. A slice of bone must be removed for the biplanar cut to allow the osteotomy closure.

Once the sawblade reaches the «hinge K-wires» the cuts are complete.

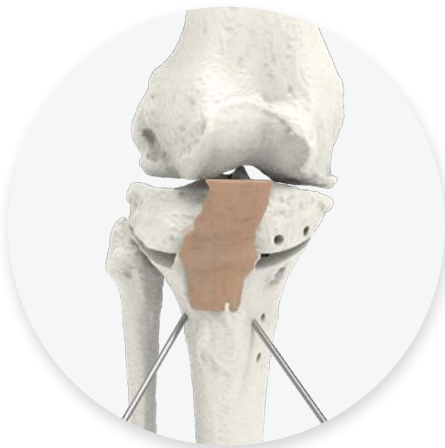

9. Remove the bone wedge

Remove the bone wedge cut and remove the «hinge K-wires» (33.0222.200).

SURGICAL TECHNIQUE

ACWHTO SUPRA-TUBERCLE - PLATE FIXATION (STEP 3/3)



10a. Plate positioning

Insert a short pin (ANC774) into the distal hole of the plate.



10b. Plate positioning

The planned closing is reached when the holes of the bone are facing the holes of the plate. Insert two short pins (ANC774) in the proximal holes.



11. Plate fixation

Remove the most anterior short pin (ANC774). Press the plate against the bone and use the countersink (ANC120-US) to prepare the first cortical.



ANC120-US

Insert a locking screw (ST4.5LxxD) using the screwdriver (ANC975).



ANC975

Perform the same steps for the second proximal short pin (ANC774).



12. Finalize the assembly

Finalize the assembly by inserting a non-locking screw in the compression hole (CT4.5LxxD) thanks to the screwdriver (ANC975).

Replace the last remaining short pin (ANC774) by a locking screw (ST4.5LxxD). Please, use the countersink (ANC120-US) to prepare the first cortical.



13. FINAL RESULT

SURGICAL TECHNIQUE

ACWHTO TRANS-TUBERCLE - TRANSPOSITION OF THE ATT (STEP 1/4)

The following surgical technique illustrates the Activmotion S anterior closing wedge high tibial osteotomy plate size 1 (BATxMD1D) with a trans-tubercle technique.



1. Guide positioning

Position the patient matched (PM) cutting guide (ANC656) for the elevation of the anterior tibial tubercle on the antero-medial surface of the tibia using the congruence of the PM cutting guide.

Caution: Please do not modify the insertion of the patellar tendon.



2. «Positioning pins» insertion

Insert Ø2.2 mm K wires (33.0222.200) in the «positioning K-wires» holes.

To check the insertion depth, measure the part of the K-wire remaining out of the hole and compare it to the one mentioned in the PM surgical technique.

Check the position of the PM cutting guide by comparing the fluoroscopy shot with the PM surgical technique.



3. Initiate the cut

Insert the sawblade in the PM cutting guide slot and initiate the cut.



4. Remove the guide

Remove the «positioning K-wires» (33.0222.200) and the PM cutting guide (ANC656).



5. Finalize the cut

Reinsert the sawblade and finalize the cut in proximal and distal, the cut must be bicortical.

Then realize the elevation of the ATT.

SURGICAL TECHNIQUE

ACWHTO TRANS-TUBERCLE - GUIDE POSITIONING (STEP 2 / 4)



6. Guide positioning

Position the PM cutting guide (ANC656) on the antero-medial surface of the tibia using the congruence of the PM cutting guide and the brackets.



7. «Cutting K-wires» insertion

Insert the Ø2.2 mm K-wires (33.0222.200) in the «cutting K-wire» holes.

To check the insertion depth, measure the part of the K-wire remaining out of the hole and compare it to the one mentioned in the PM surgical technique.



8. «Hinge K-wires» insertion

Insert the holding plots (ANC1350) in the «hinge K-wire» holes and insert the Ø2.2 mm K-wires (33.0222.200).

To check the insertion depth, measure the part of the K-wire remaining out of the hole and compare it to the one mentioned in the PM surgical technique.

Check the position of the PM cutting guide by comparing the fluoroscopy shot with the PM surgical technique.

Steps 9 to 10 for the ACWHTO trans-tubercle follow the steps 4 to 5 of the ACWHTO supra-tubercle (see page 15) .

ACWHTO TRANS-TUBERCLE - CUTTING AND PLATE FIXATION (STEP 3 & 4 / 4)



11. Initiate the cuts

Insert the sawblade in the PM cutting guide slots to initiate the cuts.

Steps 12 to 17 of the ACWHTO trans-tubercle follow the steps 7 to 12 of the ACWHTO supra-tubercle (see pages 16 & 17).



18. FINAL RESULT

Reattach the Anterior tibial tubercle and fix it with two screws.
Please use the countersink (ANC120-US) to prepare the first cortical.

SURGICAL TECHNIQUE

ACWHTO INFRA-TUBERCLE

The following surgical technique illustrates the Activmotion S anterior closing wedge high tibial osteotomy plate size 2 (BATxMD2D) with an infra-tubercle technique.

Steps 1 to 9 of the ACWHTO infra-tubercle follow the steps 6 to 14 of the ACWHTO trans-tubercle (see page 19)



10a. Plate positioning

Insert a short pin (ANC774) into the proximal hole of the distal part of the plate.

Remove the «hinge K-wires».

Caution: Please note that the most distal and proximal holes are not yet drilled in order to reduce the size of the PM cutting guide.



10b. Plate positioning

The planned closing is reached when the holes of the bone are facing the holes of the plate. Insert two short pins (ANC774).



11. Plate fixation

Press the plate against the bone and remove the proximal short pin (ANC774) near to the cut. Use the countersink (ANC120-US) to prepare the first cortical.



Insert a locking screw (ST4.5LxxD) using the screwdriver (ANC975) without locking it.



Restart the step with the second short proximal pin (ANC774).



12. Finalize the assembly

Insert the Ø4.5 mm compression screw (CT4.5LxxD) using the screwdriver (ANC975).

Remove the short distal pin (ANC774) et replace it by a locking screw (ST4.5LxxD).

Please, use the countersink (ANC120-US) to prepare the first cortical.



13. Final Result

Drill the last two holes of the plate with the guide gauge (ANC210) and the drill bit (ANC211).



14. FINAL RESULT

Insert a locking screw (ST4.5LxxD) using the screwdriver (ANC975).

Please use the countersink (ANC120-US) to prepare the first cortical.

SURGICAL TECHNIQUE

MEDIAL DISTAL FEMORAL DEROTATION - GUIDE POSITIONING (STEP 1/3)

The following surgical technique illustrates the Activmotion S medial distal femoral derotation plate (JCTxM1D). The same steps apply to the Activmotion S lateral distal femoral derotation plate (JCTxL1D).



1. Guide positioning

Position the patient-matched (PM) cutting guide (ANC717) on the medial surface (lateral surface for the JCTxL1D) of the femur using the congruence of the PM cutting guide and the anterior and posterior brackets.



2. «Cutting K-wires» insertion

Insert the Ø2.2 mm K-wires (33.0222.200) in the «cutting K-wire» holes.

To check the insertion depth, measure the part of the K-wire remaining out of the hole and compare it to the one mentioned in the PM surgical technique.

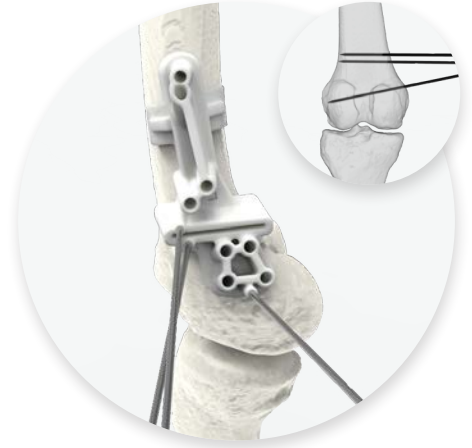

3. Positioning K-wire insertion

Insert a Ø2.2 mm K-wire (33.0222.200) in the positioning K-wire hole.

To check the insertion depth, measure the part of the K-wire remaining out of the hole and compare it to the one mentioned in the PM surgical technique.

Check the position of the PM cutting guide by comparing the fluoroscopy shot with the PM surgical technique.

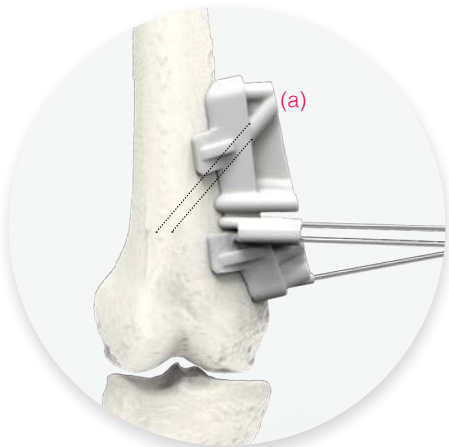

4. Drilling of the holes

Drill bicortically with the Ø4.0 mm drill bit (ANC211) the proximal holes of the PM cutting guide and monocortically (ANC211) the distal holes.

Caution: The oriented hole (a) on the proximal part of the PM cutting guide must be drilled monocortically.



5. Fixation pin insertion

Insert four long pins (ANC657), two in the distal part of the PM cutting guide and two in the proximal part, by using a mallet.

SURGICAL TECHNIQUE

MEDIAL DISTAL FEMORAL DEROTATION - CUTTING (STEP 2/3)



6. Initiate the cut

Insert the sawblade in the PM cutting guide slot and start the cut.



7. Remove the PM cutting guide

Remove the long pins (ANC657), the two cutting K-wires (33.0222.200) and the positioning K-wire (33.0222.200). Then remove the PM cutting guide (ANC717).



8. Finalize the cut

Reinsert the sawblade and finalize the cut. The cut should be bicortical.

MEDIAL DISTAL FEMORAL DEROTATION - PLATE FIXATION (STEP 3/3)



9a. Plate positioning

Insert two short pins (ANC774) into two proximal holes of the plate.



9b. Plate positioning

The planned derotation is reached when the holes of the bone are facing the holes of the plate. Insert two short pins (ANC774) in the distal part of the plate.



10. Plate fixation

Press the plate against the bone and use the countersink (ANC120-US) to prepare the first cortical of the distal and proximal holes the closest to the cut.



ANC120-US

Insert two locking screws (ST4.5LxxD) using the screwdriver (ANC975).



ANC975

SURGICAL TECHNIQUE

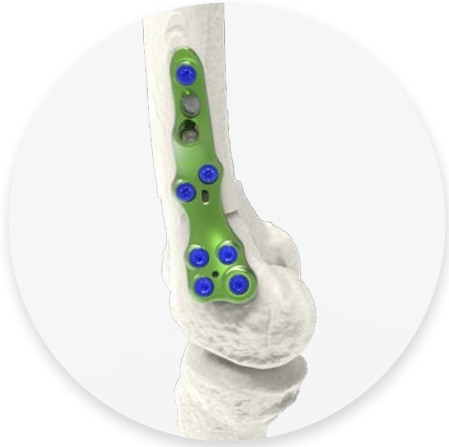

11. Finalize the assembly

Finalize the assembly by inserting the remaining $\varnothing 4.5$ mm locking screws (ST4.5LxD).

A screw must be inserted right after removing a short pin (ANC774).

Proceed by inserted alternatively proximal and distal screws getting further and further away from the osteotomy site. Use the countersink (ANC120-US) to prepare the first cortical.

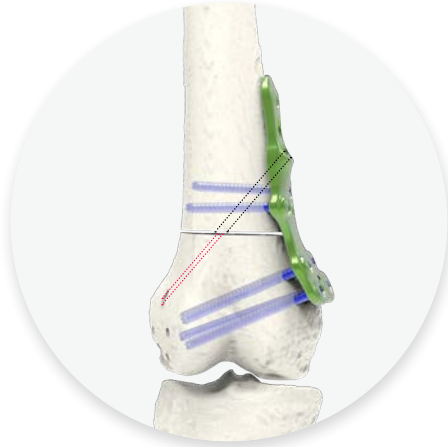

12. Insertion of the oblique screw

Complete the drilling of the oblique screw with the $\varnothing 3.5$ mm drill bit (ANC1075) or the $\varnothing 4.0$ mm drill bit (ANC1065) through the proximal hole previously performed.



Insert a non-locking screw (CT4.5LxD) using the screwdriver (ANC975).



13. FINAL RESULT

Drill the oblong hole with the guide gauge (ANC1064) and the drill bit (ANC1075). The orientation of the drill bit must be taken into account as the compression of the oblong hole is not used (1).

Insert a non-locking screw (CT4.5LxD) by using the screwdriver (ANC975).

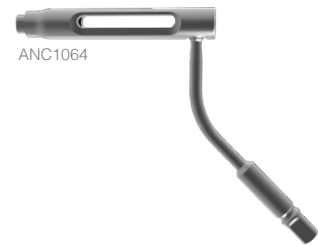

SURGICAL TECHNIQUE

MCWDFO - GUIDE POSITIONING (STEP 1/3)

The following surgical technique illustrate the Activmotion S medial closing wedge distal femoral osteotomy plate (JBTxM1D). The same steps apply for the Activmotions S lateral closing wedge distal femoral plate (JCTxL1D) and the medial closing wedge distal femoral plate (JCTxM1D).



1. Guide positioning

Position the patient-matched (PM) cutting guide (ANC717) on the medial surface of the femur (medial for the JCTxM1D and lateral for the JCTxL1D), using the congruence of the PM cutting guide and the anterior and posterior brackets.



2. «Cutting K-wires» insertion

Insert the Ø2.2 mm K-wires (33.0222.200) in the «cutting K-wire» holes.

To check the insertion depth, measure the part of the K-wire remaining out of the hole and compare it to the one mentioned in the PM surgical technique.



3. «Hinge K-wire» insertion

Insert a Ø2.2 mm K-wire (33.0222.200) in the «hinge K-wire» hole.

To check the insertion depth, measure the part of the K-wire remaining out of the hole and compare it to the one mentioned in the PM surgical technique.

Check the position of the PM cutting guide by comparing the fluoroscopy shot with the PM surgical technique.



4. Drill the holes

Drill monocortically (ANC211) through the distal holes of the PM cutting guide and bicortically (ANC211) through the proximal holes.



5. Fixation pins insertion

Insert four long pins (ANC657), two in the distal part of the PM cutting guide and two in the most proximal holes, by using a mallet.

SURGICAL TECHNIQUE

MCWDFO - CUTTING (STEP 2/3)



6. Realize the first cut

Insert the sawblade in the distal PM cutting guide slot and initiate the cut. Once the sawblade reaches the «hinge K-wire», the cut is complete.



7. Realize the second cut

Insert the sawblade in the proximal PM cutting guide slot and initiate the cut. Once the sawblade reaches the «hinge K-wire», the cut is complete.



8. Realize the biplanar cut

Insert the sawblade in the anterior PM cutting guide slot to realize the biplanar cut.

The biplanar slot is an option and **must be selected** when the case is uploaded on the portal.



9. Remove the PM cutting guide

Remove the long pins (ANC657) and the «cutting K-wires» (33.0222.200). Then remove the PM cutting guide (ANC717) by sliding it over the «hinge K-wire» (33.0222.200).



10. Remove the bone wedge

Remove the bone wedge.



11. Remove the «hinge K-wire»

Remove the «hinge K-wire» (33.0222.200).

SURGICAL TECHNIQUE

MCWDFO - PLATE FIXATION (STEP 3/3)



12a. Plate positioning

Insert two short pins (ANC774) into the two proximal holes of the plate.



12b. Plate positioning

The planned closing is reached when the holes of the bone are facing the holes of the plate. Insert two short pins (ANC774) in the distal part of the plate.



13. Plate fixation

Press the plate against the bone and use the countersink (ANC120-US) to prepare the first cortical of the distal and proximal holes the closest to the cut.



ANC120-US

Insert two locking screws (ST4.5LxxD) using the screwdriver (ANC975) without locking them.



ANC975



14. Finalize the assembly

Finalize the assembly by inserting the remaining Ø4.5 mm locking screws (ST4.5LxxD).

A screw must be inserted right after removing a short pin (ANC774).

Proceed by inserted alternatively proximal and distal screws getting further and further away from the osteotomy site. Use the countersink (ANC120-US) to prepare the first cortical.



15. FINAL RESULT

SURGICAL TECHNIQUE

LOWDFO - GUIDE POSITIONING (STEP 1/3)

The following surgical technique illustrate the Activmotion S lateral opening wedge distal femoral osteotomy plate (JATxL1D).



1. Guide positioning

Position the patient-matched (PM) cutting guide (ANC717) on the lateral surface of the femur using the congruence of the PM cutting guide and the anterior and posterior brackets.



2. «Cutting K-wire» Insertion

Insert a Ø2.2 mm K-wire (33.0222.200) in the «cutting K-wire» hole.

To check the insertion depth, measure the part of the K-wire remaining out of the hole and compare it to the one mentioned in the PM surgical technique.

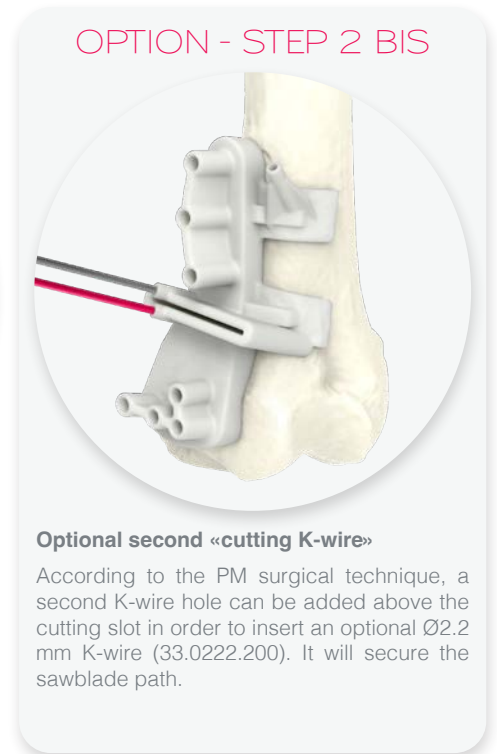

Optional second «cutting K-wire»

According to the PM surgical technique, a second K-wire hole can be added above the cutting slot in order to insert an optional Ø2.2 mm K-wire (33.0222.200). It will secure the sawblade path.

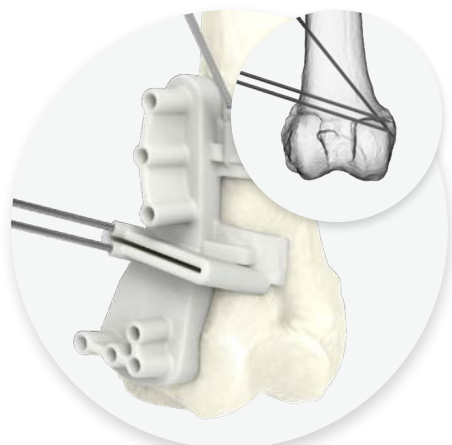

3. «Hinge K-wire» insertion

Insert the Ø2.2 mm K-wire (33.0222.200) in the «hinge K-wire» hole.

To check the insertion depth, measure the part of the K-wire remaining out of the hole and compare it to the one mentioned in the PM surgical technique.

Check the position of the PM cutting guide by comparing the fluoroscopy shot with the PM surgical technique.

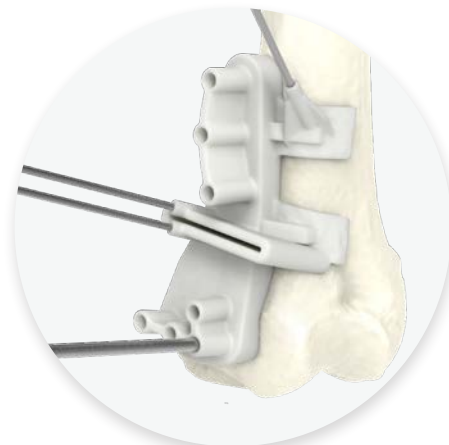

4. Drill the holes

Drill monocortically (ANC211) through the distal holes of the PM cutting guide and bicortically (ANC211) in the proximal holes.



5. Fixation pins insertion

Insert four pins (ANC657), two in the distal part of the PM cutting guide and two in the most proximal holes, by using a mallet.

SURGICAL TECHNIQUE

LOWDFO - CUTTING (STEP 2/3)

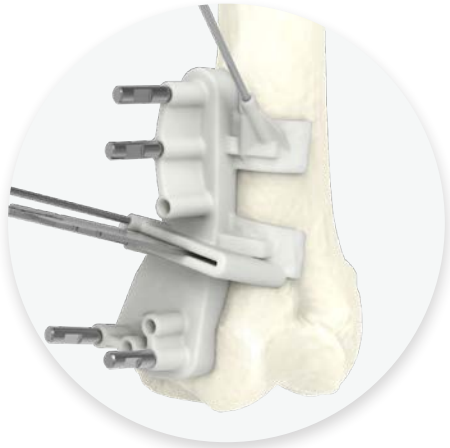

6. Realize the cut

Insert the sawblade in the PM cutting guide slot and realize the cut. Once the sawblade reaches the «hinge K-wire» the cut is complete.



7. Remove the PM cutting guide

Remove the long pins (ANC657) and the «cutting K-wires» (33.0222.200). Then remove the PM cutting guide (ANC717) by sliding it over the «hinge K-wire» (33.0222.200).



8. Perform the opening

Insert a patient-matched wedge (ANC956) or a metallic wedge for knee osteotomy (ANC019 to ANC023 and ANC025), to perform the opening.

The patient-matched wedge is an option and **must be selected** when the case is uploaded on the portal.

LOWDFO - PLATE FIXATION (STEP 3/3)



9a. Plate positioning

Insert two short pins (ANC774) into the two proximal holes of the plate.



9b. Plate positioning

The planned opening is reached when the holes of the bone are facing the holes of the plate. Insert two short pins (ANC774) in the most anterior and posterior holes.



10a. Plate fixation

Press the plate against the bone and use the countersink (ANC120-US) to prepare the first cortical of the distal and proximal screws the closest to the cut.



ANC120-US

Insert the locking screws (ST4.5LxxD) using the screwdriver (ANC975) without locking them.



ANC975

SURGICAL TECHNIQUE

OPTION - STEP 10 BIS



10b. Drill the remaining holes

According to the size of the opening or the plate position, the holes of the plate the closest to the cut might not be included on the PM cutting guide.

Drill the remaining holes using the guide gauge (ANC998) and the Ø4.0mm drill bit (ANC211). Use the countersink (ANC120-US) to prepare the first cortical.

Insert a locking screw (ST4.5LxxD) by using the screwdriver (ANC975). Remove the wedge (ANC956).

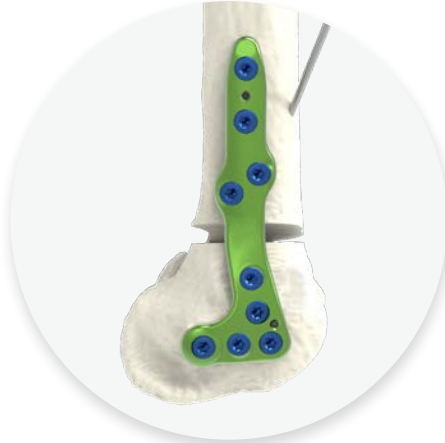

11. Finalize the assembly

Finalize the assembly by inserting the remaining Ø4.5 mm locking screws (ST4.5LxxD).

A screw must be inserted right after removing a short pin (ANC774).

Proceed by inserted alternatively proximal and distal screws getting further and further away from the osteotomy site. Use the countersink (ANC120-US) to prepare the first cortical.

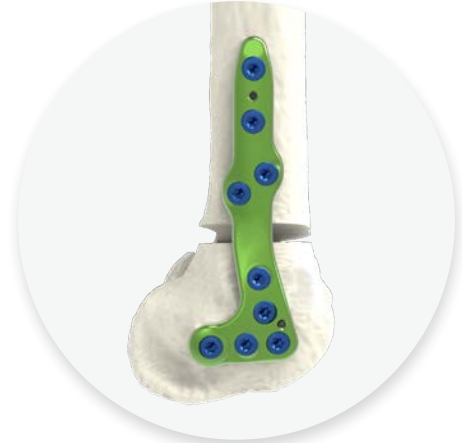

12. FINAL RESULT

Remove the «hinge K-wire» (33.0222.200).

REFERENCES

PSI

Ref.	Description
ANC656	Patient specific cutting guide for HTO
ANC717	Patient specific cutting guide for DFO
ANC927	Farabeuf pliers 170 mm
ANC657	Ø3.9 mm pin for cutting guide - L60 mm
ANC774	Ø3.9 mm pin for cutting guide - L35 mm

PSI OPTIONS

Ref.	Description
ANC1134	Patient specific cutting guide for iliac graft
ANC1135	Patient specific cutting guide for synthetic graft
ANC1184	Patient specific cutting guide for femoral head
ANC956	Patient specific wedge
ANC1350	Ø2.2 mm - L10 mm holding plot

OPTIONAL INSTRUMENTS

Ref.	Description	Qty
ANC652	HTO Alignment rod	3
ANC653	Support for HTO alignment rod	1

OPTIONAL BONE SUBSTITUTES

Ref.	Description	Qty
0106C01	Rounded wedge 06 mm	1
0108C01	Rounded wedge 08 mm	1
0110C01	Rounded wedge 10 mm	1
0112C01	Rounded wedge 12 mm	1
1414C01	Rounded wedge 14 mm	1

Manufacturer : BIOMATLANTE (FRANCE)
Class : III
Notified body: TUV - CE 0123



01xxC01

WARNING

All these products must be used with the Activmotion S instruments, make sure to order the **NewclipTechnics kit** which includes the necessary instruments.

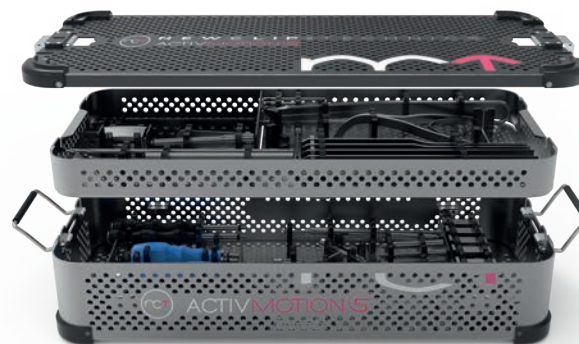

REMOVAL KIT

If you have to remove Activmotion S implants, make sure to order the **Newclip Technics removal set** which includes the following instruments:

- ANC975 : T20 screwdriver with US quick coupling system
- ANC352: Ø6 mm US quick coupling handle

An **extraction set** can also be ordered separately.

KIT DESCRIPTION

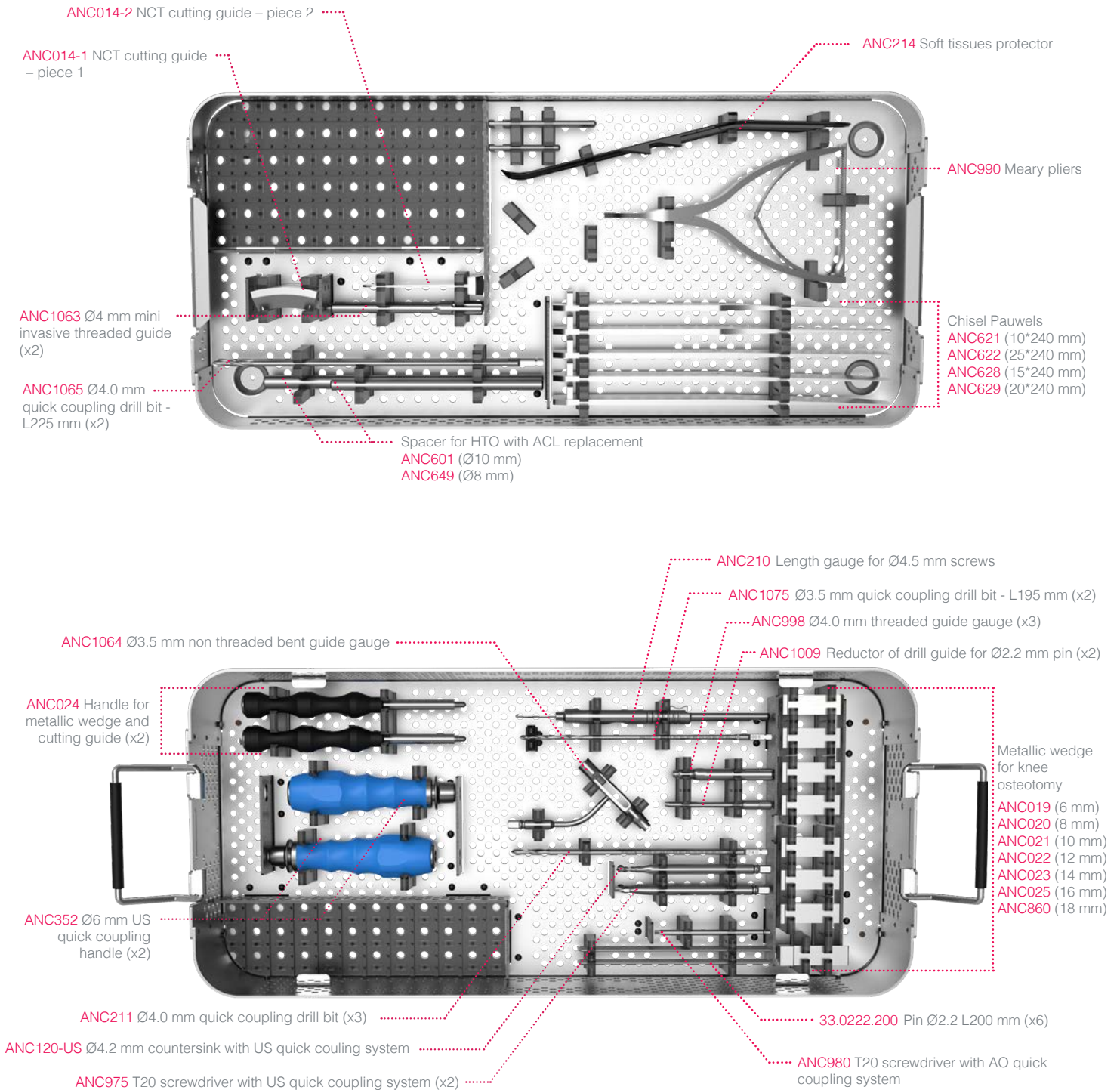

This information is intended to demonstrate the Newclip Technics portfolio of medical devices. Always refer to the package insert, product label and/or user instructions before using any Newclip Technics product. These products must be handled and/or implanted by trained and qualified staff who have read the instructions before use. A surgeon must always rely on her or his own professional clinical judgement when deciding whether to use a particular product when treating a particular patient. Product availability is subject to the regulatory or medical practices that govern individual markets. Please contact your Newclip Technics representative if you have questions about the availability of Newclip Technics products in your area.



NEWCLIP TECHNICS

.....
INNOVATION MEANS MOTION

NEWCLIP TECHNICS (HQ)

45 rue des Garotières
44115 Haute-Goulaine, France
+33 (0)2 28 21 23 25
orders@newcliptechnics.com
www.newcliptechnics.com

NEWCLIP TECHNICS IBERIA

Calle Frederic Mompou,
4b Sant just Desvern
08960 Barcelona, España
+34 937 503 421
contact@newclipiberia.com
www.newcliptechnics.com

NEWCLIP TECHNICS USA

Newclip USA
340 Tesconi Circle, Suite A
Santa Rosa CA95401, USA
+1 707 230 5078
customerservice@newclipusa.com
www.newclipusa.com

NEWCLIP TECHNICS GERMANY

Newclip GmbH
Pröllstraße 11, D-86157
Augsburg, Deutschland
+49 (0)821 650 749 40
info@newclipgmbh.com
www.newclipgmbh.de

NEWCLIP TECHNICS JAPAN

Newclip Technics Japan K.K.
KKK Bldg, 502, 3-18-1 Asakusabashi
Taito-Ku, Tokyo, 111-0053, Japan
+81 (0)3 58 25 49 81
www.newcliptechnics.com

NEWCLIP TECHNICS AUSTRALIA

Newclip Australia
3B/11 Donkin Street
West End 4101, Australia
+61 (0)2 81 886 110
solutions@newclipaustralia.com
www.newcliptechnics.com

NEWCLIP BELGIUM

Av. du Bourg,
Etienne Demunter 5
1090 Jette
Phone +32 (0)9 2311331
contact@newclipbelgium.com
www.newcliptechnics.com